

### Features

#### Compatible with 4120 Network

#### Network Display Unit provides annunciation for up to 12,000 network points:

- The basic Network Display Unit (NDU) includes a 4120 modular network interface card and functions as a special purpose master controller dedicated to providing annunciation of up to 12,000 network points
- An NDU with a Voice Command Center (VCC) mounted in the same cabinet provides an additional separate Network node with the full capability of a 4100ES fire alarm control panel including the ability to operate as the Network Voice Command Center

#### NDU master controller equipment (top bay):

- Master controller assembly with operator interface
- CPU with dual configuration programs, convenient service port access, and capacity for up to 12,000 points
- ES power supply (ES-PS) and charger (9.5 A total, 12.7 A when using optional fan module 4100-5131) with on-board alarm relay and programmable auxiliary power output
- Models available with Color ES Touch Screen Display, Monochrome 2 line x 40 Character Display, or Monochrome InfoAlarm Display
- Construction that is optimized for easy installation, upgrade, and maintenance
- Glass door (ordered separately) provides view of available operator controls visible behind locked door

#### Standard addressable interfaces include:

- Remote annunciator module support via RUI (remote unit interface) communications port

#### NDU field installed option modules include:

- DACT and City Connection
- Service modems for remote panel status inquiry
- RS-232 ports for printers or maintenance terminals
- Alarm relays and expansion power supplies
- Remote Unit Interface
- 24 Point I/O
- Fiber Optic Modems
- Physical Bridge
- BACpac Ethernet Interface
- SafeLINC Internet Interface
- Master Clock Interface

#### VCC equipment (second expansion bay):

- VCC includes ES Power Supply (ES-PS) and battery charger (9.5 A total, up to 12.7A when using optional fan module 4100-5131) with programmable function auxiliary power output
- For additional information on supported 4100ES basic panel features and specifications refer to data sheet S4100-1031
- Voice control options are similar to a networked fire alarm control panel with an extensive list of modules available for initiating, notification, and user interface (refer to data sheet S4100-1034 for details)

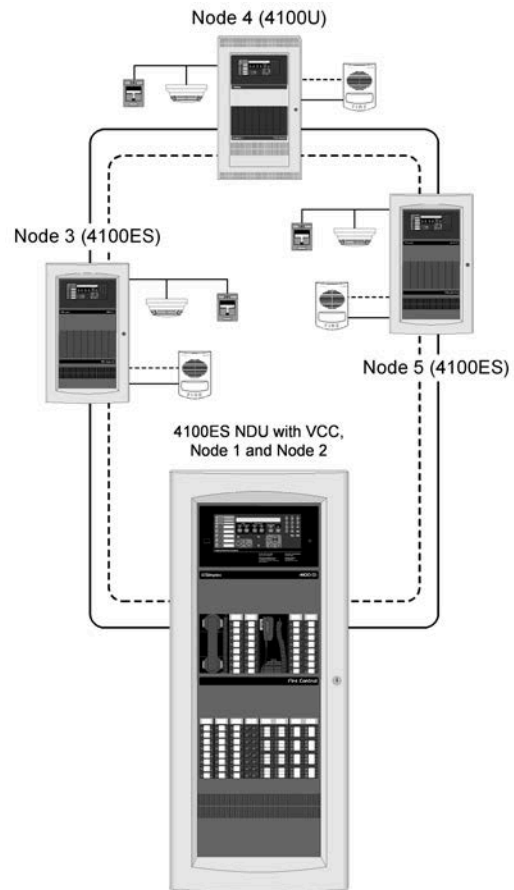

Figure 1: Network One-Line Diagram Showing an NDU with VCC

#### Listings Information\*:

- UL 864, Fire Detection and Control (UOJZ), Smoke Control Service (UUKL), Releasing Device Service (SYZV)
- UL 1076, Proprietary Alarm Units - Burglar (APOU)
- UL 2017, Process Management Equipment (QVAX), Emergency Alarm System Control Units (FSZI)
- UL 1730, Smoke Detector Monitor (UULH)
- UL 2572, Mass Notification Systems (PGWM)
- CAN/ULC-S527 Control Units for Fire Alarm Systems (UOJZ7), Releasing Device Service (SYZV7)
- ULC/ORD-C1076 Proprietary Burglar Alarm Units and Systems (APOU7)
- ULC/ORD-C100 Smoke Control System Equipment (UUKL7)

#### Software Feature Summary:

- Selectable service override allows authorized operators to clear alarm conditions during System Reset even if status has gone to trouble before reset occurred
- Duplicate address error detection
- Convenient PC programming using a Microsoft Windows user interface based program.

\* This product has been approved by the California State Fire Marshal (CSFM) pursuant to Section 13144.1 of the California Health and Safety Code. See CSFM Listing 7165-0026:0251 and 7165-2269:0542 for allowable values and/or conditions concerning material presented in this document. Additional listings may be applicable; contact your local product supplier for the latest status.

## Introduction

The **4100ES NDU with VCC** is a 4120 network level annunciator and manual system/point controller with optional network voice control equipment. It provides alphanumeric annunciation for up to 12,000 Network points and/or point lists and can be programmed to function as the network master controller for Alarm Silence, Trouble Acknowledge, and System Reset.

**4120 Network Overview.** When connected to other 4120 Network nodes, individual fire alarm control panels become components of a distributed intelligence system. Each panel that directly connects to the 4120 network is called a network “node” and is capable of performing individual supervision and control on its locally connected devices but has the ability to inform the 4100ES NDU (as well as other network control panels) of point status and panel condition. This allows system information to reach the proper location for appropriate system response.

Multiple 4100ES NDUs (separately packaged) can be connected to a 4120 Network to duplicate common information at separate locations, or direct selected information by type such as troubles, alarms, control, etc.

## NDU Module Bay Description

The **NDU Master Controller Bay** (top) includes a special purpose ES power supply with battery charger (ES-PS), the master controller board, a 4120 modular network interface card, expansion space for optional features and operator interface equipment similar to that used on the standard fire alarm control modules.

The **Optional NDU VCC** includes an expansion bay with separate master controller board, 4120 modular network interface card, expansion space for optional features and an ES-PS power supply. This results in two separate network nodes residing within the same cabinet. Optional LED/switch modules can also be mounted in the VCC bay. For 2-bay cabinets, the VCC mounts in bay 2. For 3-bay cabinets as shown to the right, the VCC mounts in the second expansion bay, bay 3.

The **Battery Compartment** (bottom) accepts two batteries, up to 50 Ah, to be mounted within the cabinet without interfering with module space.

Refer to the NDU with VCC internal module bay reference illustration for typical three bay cabinet module location.

## Packaging Availability

- Modules are power-limited (unless specifically noted otherwise)
- Enclosure are available for one, two, or three bay sizes or for cabinet rack mounting
- Additional cabinets can be mounted close-nipped for module expansion
- NEMA 1/IP30 boxes, doors with tempered glass inserts, and dress panels are available in platinum or red, (ordered separately)
- Refer to data sheet *S4100-0037* for enclosure details

## NDU with VCC Internal Module Bay Reference

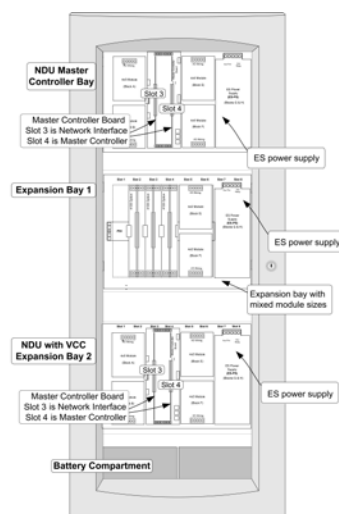

Figure 2: NDU with VCC Internal Module Bay Reference (exact layout is determined by specific system requirements)

**Operator Interface Detail Reference**

4100ES Fire Alarm Control Units are provided with either an enhanced Color ES Touch Screen Display or a basic Monochrome 2 Line by 40 Character operator interface depending on the model selected (*for information on Monochrome InfoAlarm display refer to data sheet S4100-1045*). The following illustrations highlight the primary functions of each.

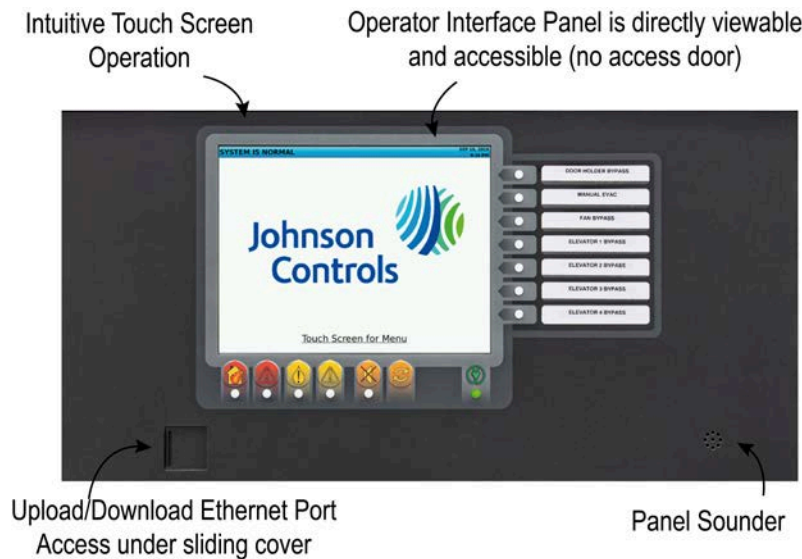

Figure 3: ES Touch Screen Display Interface

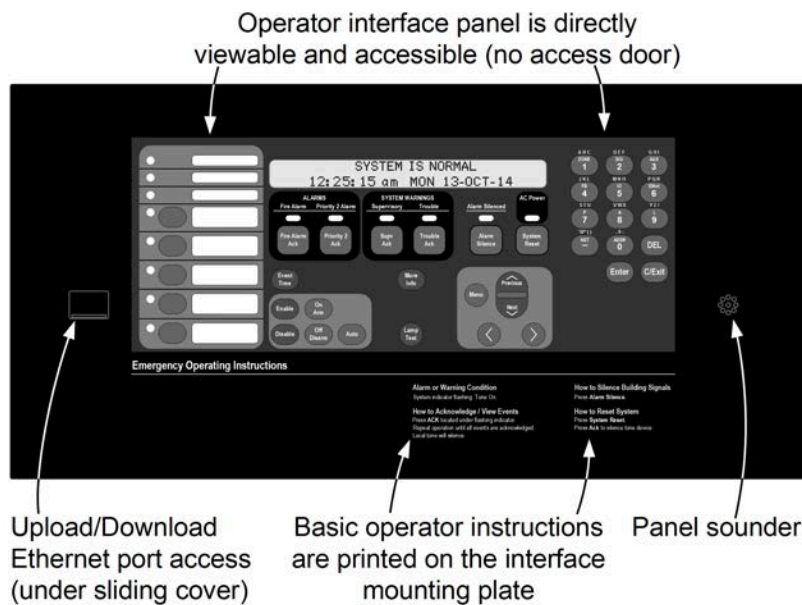

Figure 4: Monochrome 2 Line x 40 Character Display

## Color ES Touch Screen Display

The Color ES Touch Screen Display interface offers intuitive operation similar to a tablet or smart phone. With a larger area format versus an individual text line display, more information is available at a glance, and minimal key presses are needed to access detailed information.

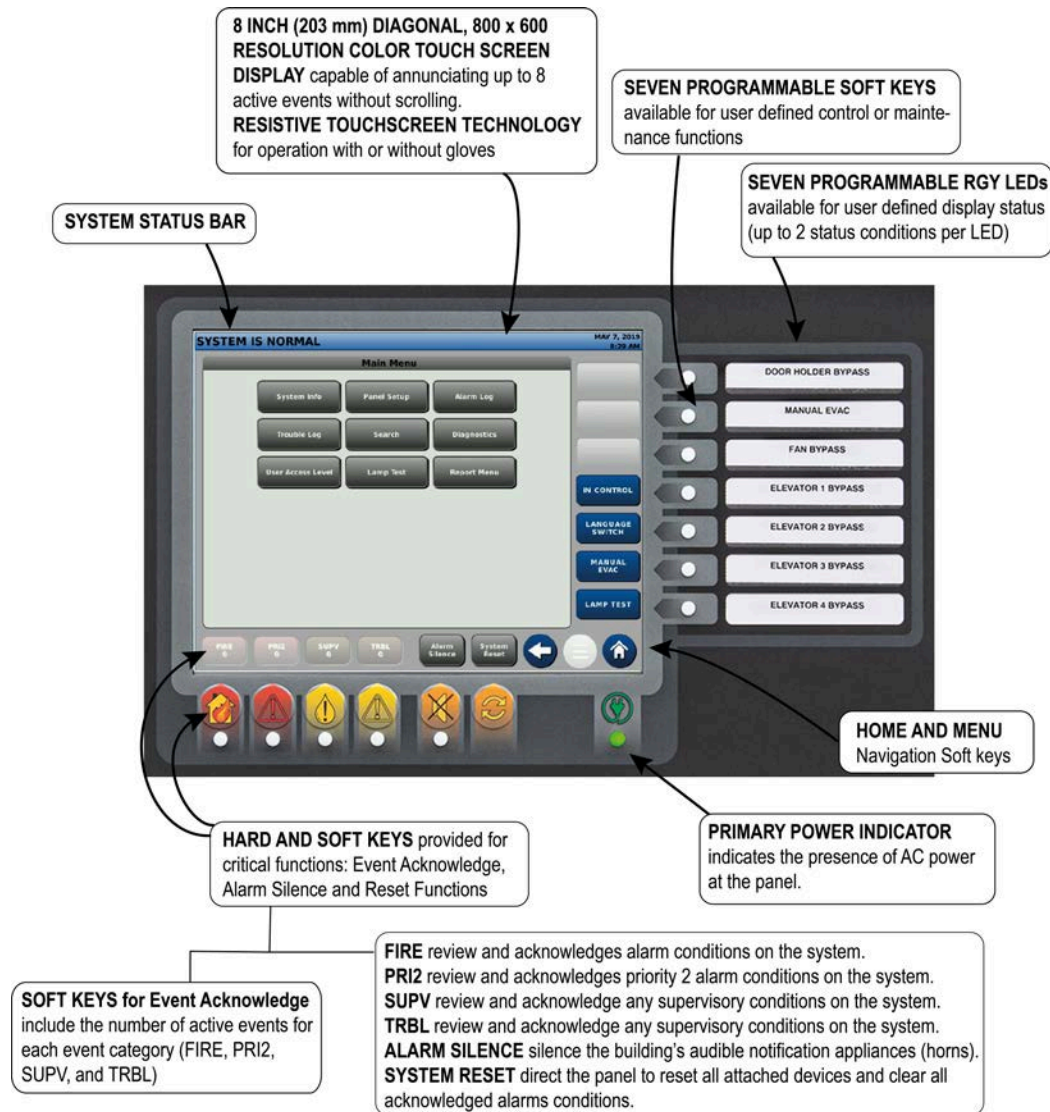

Figure 5: ES Touch Screen Display Operator Interface

## Features

### ES Touch Screen Displays provide customized operating experience

- Event activity display choices include: First 8 Events; or First 7 Events with emphasis on Most Recent; or First 6 Events with emphasis on First and Most Recent (individually selectable for each event type)
- System reports are easily viewable; logs can be read with minimal scrolling
- Up to two languages are available per system, easily selected by programmable key press
- Information sent to Remote ES Touch Screen Displays can be vectored by point or zone
- Both Hard and Soft keys available for critical functions: Event Acknowledge, Alarm Silence, and Reset Functions
- Resistive touchscreen technology allows operation with or without gloves
- Seven programmable RGY LEDs available for user-defined display status (up to 2 status conditions per LED)
- Seven programmable Soft keys available for user-defined control or maintenance functions
- PRI2 Soft key label can be changed to CO to annunciate Carbon Monoxide detection status
- ES Touch Screen Display can be programmed to report individual points or groups of points as a single zone
- Supports ability to display a custom watermark background file of a company logo or other desired display content
- Seismically compliant under the State of California Statewide Office of Housing and Development (OSHPD) Special Seismic Certification (SSC) program guidelines. Refer to *Simplex Seismic Application Guide* 579-1213 and *Battery Brackets for Seismic Activity Applications* S2081-0019 for details.

**Display properties**

- 8 inch (203 mm) diagonal, 800 x 600 resolution color touch screen display capable of annunciating up to 8 active events without scrolling
- Bright white LED backlighting provides efficient and long lasting illumination; backlight is dim in quiescent state, automatically switches to full power on touch or on event activity in system.

**Description**

ES Touch Screen Displays for 4100ES fire alarm systems provide a large display with extended information content, dual language support including UTF-8 character languages, and an intuitive control key interface per the following:

- Up to 10 ES Touch Screen Displays are supported per 4100ES control panel; able to allow one ES Touch Screen Display to take-control and to designate access levels for interfaces not in-control; programmable LEDs can be assigned to in-control status indications
- Menu-driven format conveniently prompts operators for the next action required
- Direct point callup displays individual points alphabetically and then homes in on the logical choice as more point information is entered
- Event categories are color coded for quick visual representation; Red for Alarm and Priority 2 Events; Yellow for Supervisory and Trouble events
- Date formats are either MM/DD/YY or DD/MM/YY
- Time formats are either 24 hour or 12 hour with AM/PM
- System Normal screen supports a color background (watermark) for company name, company logo, or other desired display content

Example Display Screens

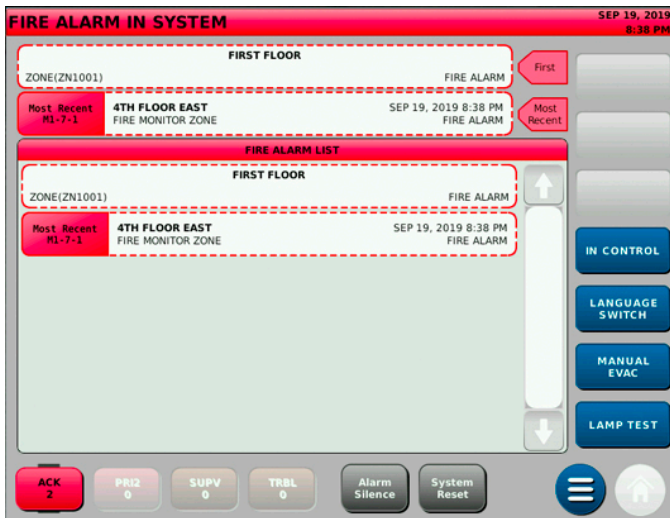

Figure 6: First and Most Recent Alarm Display



Figure 7: Main Menu



Figure 8: First Eight Active Trouble Events List



Figure 9: Direct Point Callup

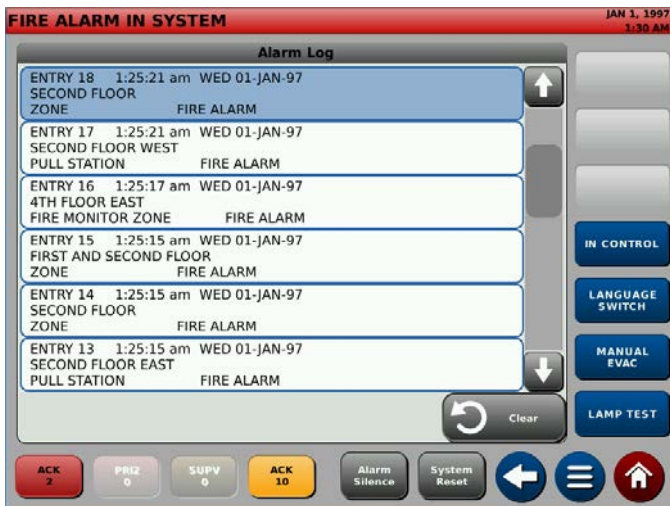

Figure 10: Alarm History Log

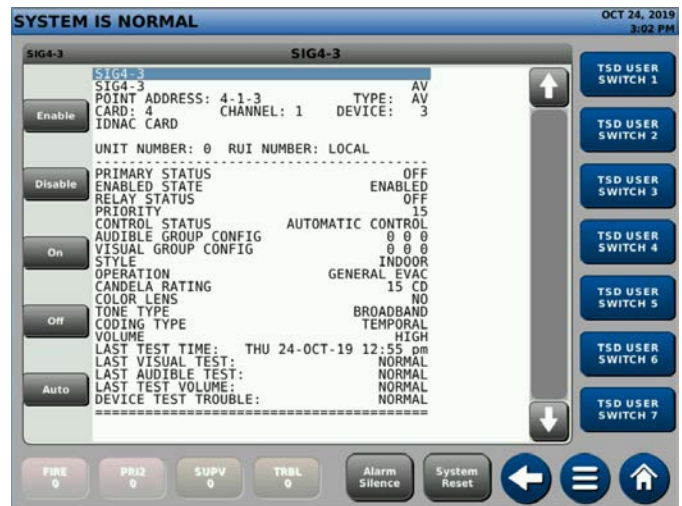

Figure 11: Detailed Point Status Screen for TrueAlert ES Appliance

---

## Specifications

**Table 1: General ES Touch Screen Display Specifications**

<b>Specification</b>	<b>Rating</b>
Resolution	800 x 600 Pixels (RGB)
Size / Type	8 inch (203 mm) Diagonal / Color Touch Screen
Touch Screen Technology	Resistive
Event Display	Up to 8 Events without scrolling
Normal Screen Custom Watermark File Format	680 x 484 Pixels: BMP, JPG, TIFF, GIF or PNG file format
Environmental	Operating Temperature: 32°F to 120°F (0°C to 49°C) Operating Humidity: Up to 93% RH, non-condensing @ 90°F (32°C) maximum

### Operator Interface with Monochrome 2 x 40 LCD

- Convenient and extensive operator information is provided using a logical, menu-driven display
- Multiple automatic and manual diagnostics for maintenance reduction
- Alarm and Trouble History Logs (up to 1250 entries for each, 2500 total events) are available for viewing from the LCD, or capable of being printed to a connected printer, or downloaded to a service computer
- Convenient PC programmer label editing
- Password access control

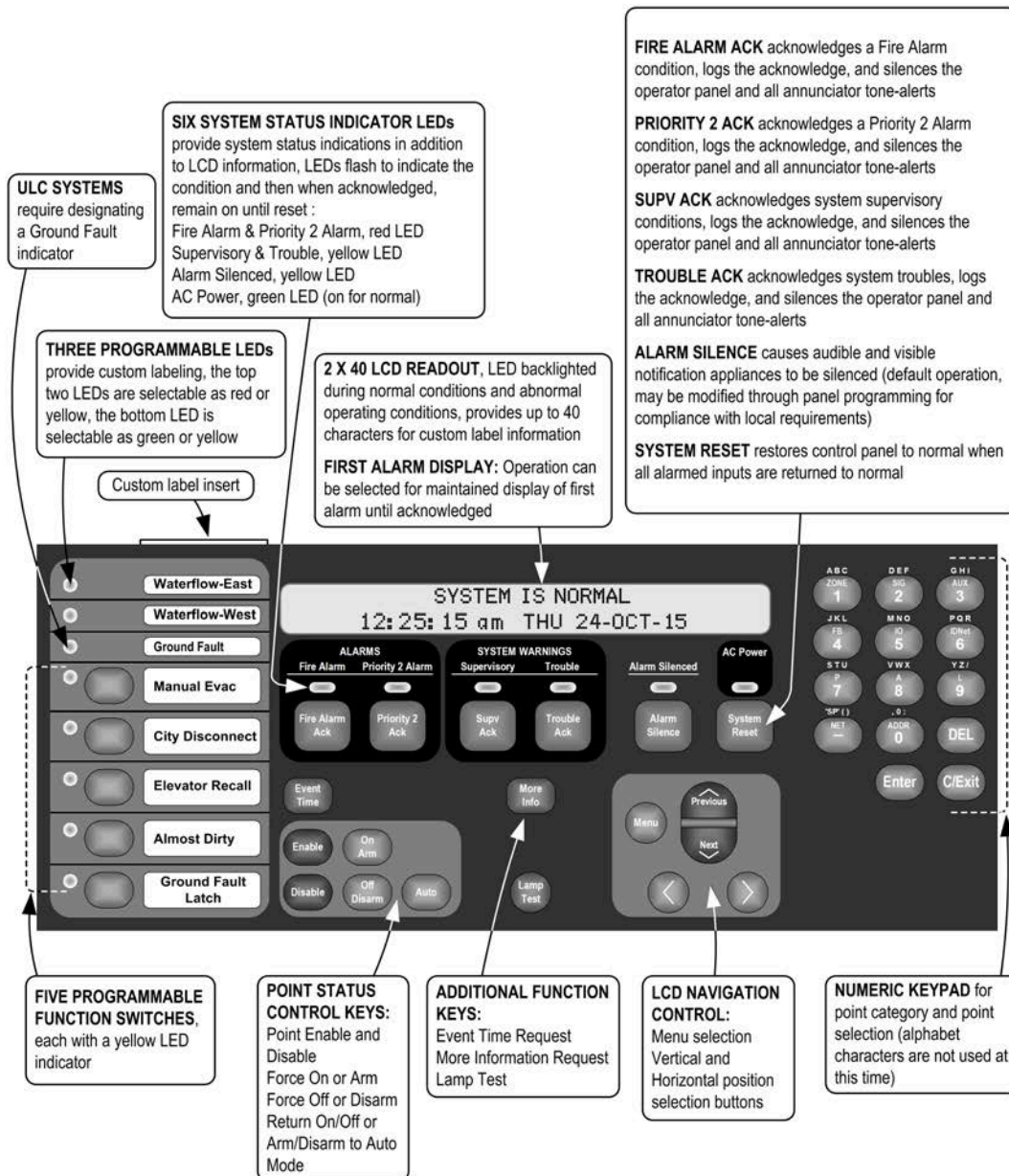

Figure 12: Operator Interface Features



## Standard Module Details

### NDU (top bay) master controller & motherboard includes a master controller, master controller motherboard, 4120 Modular NIC, and ES-PS power supply:

- The master controller mounts in slot 4 of a two slot motherboard (slots 3 and 4 of the master controller bay) and provides one RUI+ communications channel (Class B or Class A), available at slot 4. A 4120 network interface card is mounted in slot 3.
- The NDU bay RUI+ communications output (configurable for isolated or un-isolated operation) supports up to 31 devices per master controller at up to 2500 ft (762 m) for single run, or 10,000 ft (3048 m) total if wiring is Class B and T-tapped. If more distance is required, up to four total RUI channels are supported per master controller (up to three 4100-1291 RUI expansion modules may be added). 4100-1291 provides un-isolated RUI communications.
- Both the NDU master controller RUI+ output and RUI expansion modules support the following remote LCD annunciators: 4603-9100 series LCD annunciators and 4100-9400 series remote InfoAlarm command centers, 4100 series 24 I/O and LED/switch modules and 4602 series status command units (SCU), remote command units (RCU) and graphic I/O modules (4602 series equipment requires un-isolated output).
- ES power supply (ES-PS) is rated for 9.5 A total, 12.7 A when using optional fan module 4100-5131; includes battery charger, one 2 A aux power output, two block spaces for compatible optional modules and provisions for either an optional City Connect Module or an optional Alarm Relay Module (**Note:** City Connect or Alarm Relay module requires one available block space, refer to data sheet S4100-1031 for additional details).
- Battery charger is dual rate, temperature compensated, and charges up to 50 Ah sealed lead-acid batteries mounted in the battery compartment (33 Ah for single bay cabinets); also is UL and ULC listed for charging up to 110 Ah batteries mounted in an external cabinet (see data sheet S2081-0012 for details)
- Battery and charger monitoring includes battery charger status and low or depleted battery conditions; status information provided to the master controller includes analog values for: battery voltage, charger voltage and current, actual system voltage and current, and individual IDNAC SLC currents
- Low battery cutout is selectable for each ES-PS power supply
- Outputs are power-limited, except for the battery charger and city circuits
- **Note:** ES-PS aux relay is disabled in NDU bay.

### ES-PS Power Supply Mounted Optional Modules (select one):

- **City Connect Module** (4100-6031, with disconnect switches, or 4100-6032, without disconnect switches) can be selected for conventional dual circuit city connections (requires one block space)
- **Alarm Relay Module** (4100-6033) provides three Form C relays that are used for Alarm, Trouble, and Supervisory, rated 2 A resistive @ 32 VDC (requires one block space)

### VCC (expansion bay) includes a master controller, master controller motherboard, 4120 NIC and ES-PS power supply:

- The master controller mounts in slot 4 of a two slot motherboard (slots 3 and 4 of the master controller bay) and provides one RUI+ communications channel (Class B or Class A), available at slot 4. A 4120 network interface card is mounted in Slot 3.
- The VCC bay RUI+ communications output (configurable for isolated or un-isolated operation) supports up to 31 devices per master controller at up to 2500 ft (762 m) for single run, or 10,000 ft (3048 m) total if wiring is Class B and T-tapped. If more distance is required, up to four total RUI channels are supported per master controller (up to three 4100-1291 RUI expansion modules may be added). 4100-1291 provides un-isolated RUI communications.
- Both the VCC master controller RUI+ output and RUI expansion modules are compatible with the following equipment: miniplex transponders, 4603-9100 series LCD annunciators, 4100-9400 series remote InfoAlarm command centers, 4100 series 24 I/O and LED/switch modules and 4602 series status command units (SCU), remote command units (RCU) and graphic I/O modules (4602 series equipment requires un-isolated output).
- ES power supply (ES-PS) is rated for 9.5 A total (up to 12.7A when using optional fan module 4100-5131); includes battery charger, one 2 A output configurable for auxiliary power or simple NAC operation, 2 block spaces for compatible optional modules and provisions for either an optional City Connect Module or an optional Alarm Relay Module. **Note:** City Connect or Alarm Relay module requires one available block space, refer to data sheet S4100-1031 for additional details.
- Battery charger is dual rate, temperature compensated, and charges up to 50 Ah sealed lead-acid batteries mounted in the battery compartment (33 Ah for single bay cabinets); also is UL and ULC listed for charging up to 110 Ah batteries mounted in an external cabinet. Refer to data sheet S2081-0012 for details.
- Battery and charger monitoring includes battery charger status and low or depleted battery conditions; status information provided to the master controller includes analog values for: battery voltage, charger voltage and current, actual system voltage and current, and individual IDNAC SLC currents
- Low battery cutout is selectable for each ES-PS power supply
- Outputs are power-limited, except for the battery charger and city circuits

### 2 A Programmable Output:

- Select for conventional NAC operation to provide supervised reverse polarity for sounder base power, suppression release peripheral (SRP) power, and other coded NAC operation requirements
- Select for auxiliary (AUX) operation for sounder base power, four-wire detector power, or door holder; supervised AUX operation does not require an end-of-line relay to provide power-limited operation

**ES-PS Power Supply Mounted Optional Modules (select one):**

- **City Connect Module** (4100-6031, with disconnect switches, or 4100-6032, without disconnect switches) can be selected for conventional dual circuit city connections (requires one block space)
- **Alarm Relay Module** (4100-6033) provides three Form C relays that are used for Alarm, Trouble, and Supervisory, rated 2 A resistive @ 32 VDC (requires one block space)

**NDU and NDU VCC Panel Selection**
**Table 2: Network Display Unit, Non-Voice**

Model	Input Power	Includes	Listing	Supv.	Alarm
4100-9720	120 to 240 VAC	<b>NDU Master Controller Bay</b> with English 2x40 Display, CPU Card, 4120 Network Interface Card, ES Power Supply (120 V to 240 V 50/60 Hz, 24V Aux. Relay, 24 V Aux. Power Tap, 110 Ah Battery Charger) and external RUI+ (isolated or un-isolated) communications interface See <a href="#">Media Card Selection for NDU and NDU VCC 4120 Modular Network Interface Cards</a> for selected Network Media Card current	UL/ULC	323 mA	367 mA
4100-9721		Same as 4100-9720 except with Canadian French user interface	ULC		
4100-9722		Same as 4100-9720 except with English InfoAlarm user interface with raised keys	UL/ULC	395 mA	437 mA
4100-9723		Same as 4100-9720 except with Canadian French InfoAlarm user interface with raised keys	ULC		
4100-9724		Same as 4100-9720 except with InfoAlarm user interface with flat keys and slide in labels	UL/ULC		
4100-9725		Same as 4100-9720 except with <b>Color ES Touch Screen Display</b>	UL/ULC, CSFM	408 mA	487 mA

**Table 3: Network Display Unit with Voice Command Center (VCC)**

Model	Input Power	Includes	Listing	Supv.	Alarm
4100-9730	120 to 240 VAC	<b>NDU Master Controller Bay</b> with English 2x40 Display, CPU Card, 4120 Network Interface Card, ES Power Supply (120 V to 240 V 50/60 Hz, 24 V Aux. Relay, 24 V Aux. Power Tap, 110 Ah Battery Charger) and external RUI+ (isolated or un-isolated) communications interface <b>VCC Master Controller Bay</b> with CPU Card, 4120 Network Interface Card, IDNet 2 Card supports up to 250 addressable/ analog points, ES Power Supply (120 V to 240 V 50/60 Hz, 24 V Aux. Relay, 24 V Aux. Power Tap, 110 Ah Battery Charger) and external RUI+ (isolated or un-isolated) communications interface See <a href="#">Media Card Selection for NDU and NDU VCC 4120 Modular Network Interface Cards</a> for selected Network Media Card current	UL/ULC	636 mA	689 mA
4100-9731		Same as 4100-9730 except with Canadian French user interface in NDU Master Controller Bay	ULC		
4100-9732		Same as 4100-9730 except with English InfoAlarm user interface with raised keys in NDU Master Controller Bay	UL/ULC	708 mA	759 mA
4100-9733		Same as 4100-9730 except with Canadian French InfoAlarm user interface with raised keys in NDU Master Controller Bay	ULC		
4100-9734		Same as 4100-9730 except with InfoAlarm user interface with flat keys and slide in labels in NDU Master Controller Bay	UL/ULC		
4100-9735		Same as 4100-9730 except with <b>Color ES Touch Screen Display</b>	UL/ULC, CSFM	721 mA	809 mA

**Note:**

1. See [NDU Equipment Selection](#) and [VCC Equipment Selection](#) for compatible NDU and VCC equipment options.
2. See [Standard Module Details](#) for additional system power supply information.
3. ES Net media card current is listed separately, see relevant media specifications for more details.
4. For additional information on ES Net products and specifications refer to data sheet S4100-0076.
5. For additional information on InfoAlarm Command Center expanded content displays refer to data sheet S4100-1045.
6. For panels listed in Table 3, order audio modules separately as required.

**Media Card Selection for NDU and NDU VCC 4120 Modular Network Interface Cards**

For additional information on 4120 fire alarm products and specifications, refer to data sheet S4100-0056.

**Table 4: Media cards for 4120 Modular Network Interface Cards**

Model	Description		Size	Supv	Alarm
4100-6056	Wired network media card	Select per network connection requirements; mounts on the supplied modular network interface cards; up to two media cards are required per network interface card; supports Class B or X operation	N.A.	55 mA	55 mA
4100-6301	Left port, single-mode 4120 duplex fiber media card	Select per network connection requirements; mounts on the supplied modular network interface cards; up to two media cards are required per network interface card; supports Class B or X operation. Maximum of one left port and one right port duplex fiber media card per modular network interface card; field connections require left port to right port pairing. Order fiber media service kits for retrofit jobs where ST connectors are already installed. Refer to data sheet S4100-0056 for full fiber media module specifications and retrofit information.	N.A.	55 mA	55 mA
4100-6302	Right port, single-mode duplex 4120 fiber media card		N.A.	55 mA	55 mA
4100-6303	Left port, multi-mode 4120 duplex fiber media card		N.A.	55 mA	55 mA
4100-6304	Right port, multi-mode 4120 duplex fiber media card		N.A.	55 mA	55 mA
4100-6055	Network access dial-in service modem, mounts to supplied network interface card, requires telephone line connection		N.A.	60 mA	60 mA

**Note:** Order fiber media service kits for retrofit jobs where ST connectors are already installed. See [Fiber media card service kits](#) for additional information.

## Fiber media card service kits

**Table 5: ES Net fiber media card service kits**

Model	Fiber type	Description
4100-6412	50/125 $\mu$ m multi-mode	For use in retrofit jobs where fiber optic cables with ST connectors are already installed. Includes one ST to SC 18 in. (45.7 cm) fiber optic patch cord, one ST-ST coupler, one wire clamp, and one insulating sleeve.
4100-6413	62.5/125 $\mu$ m multi-mode	
4100-6414	9/125 $\mu$ m single-mode	

**Note:** Fiber optic media cards must be of the same type on each end of the fiber link. When replacing a media card with a different type, the card on the other end of the link must be replaced with a fiber optic media card of the same type.

## NDU Equipment Selection

The NDU functions as a special purpose master controller dedicated to providing annunciation of up to 12,000 network points. The following information provides equipment selection for the basic Network Display Unit (NDU). All features for the NDU are also applicable to the VCC. The primary product data sheets for NDU equipment are S4100-1031 Basic Panel Equipment and S4100-0056 4120 Network Products and Specifications.

**Table 6: NDU Equipment Selection**

Model	Description		Size	Supv.	Alarm
4100-1291	Remote Unit Interface module (RUI); up to three maximum per control panel		1 Slot	85 mA	85 mA
4100-6031	<b>Select one per ES Power Supply (non power-limited)</b>	City Circuit, with disconnect switches	1 Block	20 mA	36 mA
4100-6032		City Circuit, without disconnect switches		20 mA	36 mA
4100-6033		Alarm/Supv/Tbl Relay, 3 Form C relays, 2 A @ 32 VDC		15 mA	37 mA
4100-6038	Dual RS-232 Interface; 3 maximum; can mount in Slot 3 or Slot 2 of Master Controller	3 maximum of RS-232 type modules per panel	1 Slot	132 mA	132 mA
4100-6046	Dual Port RS-232 standard interface (4 x 5 module)		1 Block	60 mA	60 mA
4100-6080	Side Mount DACT, Point or Event Reporting; 1 shipped unless 4100-7908 is selected; 2 max. per system; includes 2, 2080-9047 cables, 14 ft (4.3 m) long, RJ45 plug and spade lugs		1 Slot	30 mA	40 mA
4100-9816	Master Clock Interface Module with one standard RS-232 port (see S4100-0033)		1 Slot	132 mA	132 mA
4100-6079	Safelinc internet interface module		2 Slots	145 mA	145 mA
4100-1290	24 Point I/O Module		1 Slot	34 mA	75 mA
4100-6072	Single-Mode Left Port Fiber Modem Assembly	2 Vertical Blocks	Refer to S4100-0049 for additional details		
4100-6073	Single-Mode Right Port Fiber Modem Assembly				
4100-6074	Multi-Mode Left Port Fiber Modem Assembly				
4100-6075	Multi-Mode Right Port Fiber Modem Assembly				
4100-6069	BACpac Ethernet Module – 1500 Points				
			1 Slot	123 mA	123 mA

**Table 6: NDU Equipment Selection**

Model	Description	Size	Supv.	Alarm
4100-6110	BACpac Ethernet Module – 5,000 Points	1 Slot	123 mA	123 mA
4100-6111	BACpac Ethernet Module – 15,000 Points	1 Slot	123 mA	123 mA
4100-6101	Physical Bridge Module Class B	1 Slot	210 mA	210 mA
4100-6102	Physical Bridge Module Class X	2 Slots	300 mA	300 mA

**Table 7: ES Power Supplies**

Model	Voltage	Description	Includes	Provides Power to Bay	Size	Supv.	Alarm
4100-5401	120-240 V 50/60 Hz	ES-PS	24 V Aux. Relay, 24 V Aux. Power 2 A Tap/ Simple NAC, 110 Ah Battery Charger, 2 PDI Blocks for option cards.	Yes	2 Blocks	68 mA	77 mA
4100-5402	120-240 V 50/60 Hz	ES-XPS	Same as ES-PS above except without battery charger.	No			

**Table 8: Power supply accessories**

Model	Description	Size	Current
4100-5152	12 VDC Power Option, 2 A maximum	1 Block	1.5 A maximum
4100-0156	8 VDC Converter, required for multiple Physical Bridge Modules, 3 A maximum	1 Block	included w/loads
4100-5130	Voltage Regulator Module, 22.8 to 26.4 VDC (25VDC nominal); isolated and resettable output; includes earth detection circuit and trouble relay for status monitoring.	1 Block	3 A maximum with 2.5 A load, 4.9 A maximum with 4 A load
4100-5131	ES-PS Fan Module, allows more than one power supply to be installed in a single bay and may increase total DC output power capacity per power supply. See Table 9 for specifications.	N/A	0 mA Supv. 200 mA Alarm
4100-0636	Box Interconnection Harness Kit (non-audio); order one for each close-nipped cabinet		
4100-0638	4100 Slot Module Additional 24 VDC Harness; needed when 4100 Slot module requirements exceed 2 A from ES-PS		
4100-5403	Harness for ES-PS Backup Power Supply		
4100-0644	120 VAC PDM Harness	1 PDM harness is required per power supply, select as required for appropriate input voltage	
4100-0645	220 VAC PDM Harness		
4100-0646	230 VAC PDM Harness		
4100-0647	240 VAC PDM Harness		

## General Specifications

**Table 9: ES Power Supply Specifications (ES-PS and ES-XPS)**

Specifications	Rating
<b>AC Input Power</b>	120 to 240 VAC
120 VAC	3.72 A
220 - 240 VAC	1.82 A
<b>Total DC Output Power Capacity</b>	
Without Fan	9.5 A
With 4100-5131 Fan and 4100-5451 IDNAC Module(s)	9.7 A
With 4100-5131 Fan (without 4100-5451 IDNAC Module)	12.7 A
With Regulated 24V Appliance Loads (with or without 4100-5131 Fan)	5.0 A
<b>Special Application Appliance Loads:</b> supports full total DC output power capacity ratings above	Simplex horns, strobes, and combination horn/strobes and speaker/strobes (contact your Simplex product representative for compatible appliances)
<b>Regulated 24V Appliances:</b> reduces total DC output power capacity to 5.0 A	Power for other UL listed appliances; use associated external synchronization modules where required
<b>Auxiliary Power Tap</b>	2 A maximum (taken from total output power capacity)
<b>NACs Programmed for Auxiliary Power</b>	3 A maximum per NAC, 5 A maximum total (taken from total output power capacity)
<b>Battery Charger (ES-PS only)</b>	Sealed Lead-Acid Batteries
Battery Ah Capacity	UL/ULC listed for battery charging of up to 110 Ah (batteries larger than 50 Ah require a remote battery cabinet)
Charger characteristics and performance	Temperature compensated, dual rate, recharges depleted batteries within 48 hours
<b>Environmental</b>	
Operating Temperature	32°F to 120°F (0°C to 49°C)

**Table 9: ES Power Supply Specifications (ES-PS and ES-XPS)**

Specifications	Rating
Operating Humidity	Up to 93% RH, non-condensing @ 90°F (32°C) maximum
<b>Option Card Mounting</b>	Two vertical blocks are available for compatible modules (refer to 579-1288 installation instructions for additional details)

## VCC Equipment Selection

The Voice Command Center (VCC) is a separate network node mounted within the same cabinet as the NDU. The VCC has the full capability of a 4100ES fire alarm control panel including the ability to operate as the Network Voice Command Center. While the NDU has a limited equipment selection, equipment selection for the VCC includes all the features supported by 4100ES fire alarm control panels. Please refer to the 4100ES and 4120 Network Product Data Sheets referenced below for VCC equipment selection information.

**Note:** The primary data sheet references for VCC equipment selection are:

- S4100-1034: Emergency Voice/Alarm Equipment
- S4100-0032: LED/Switch Modules & Printer
- S4100-1031: Basic Panel Equipment
- S4100-0056: 4120 Network Products and Specifications

**Table 10: Additional 4100ES and 4120 Network Product Reference**

Subject	Datasheet
Serial DACT (SDACT) for 4100ES, 4010ES, 4007ES	S2080-0009
Battery and Battery Cabinet Reference for 4100ES	S2081-0006
110 Ah Batteries and Cabinets for 4100ES	S2081-0012
External 110 Ah Battery Charger for 4100ES, 4010ES	S4081-0002
TCP/IP Physical Bridge Modules for 4120 Networks	S4100-0029
4100ES LED/Switch Modules & Printer	S4100-0032
4100ES Enclosures	S4100-0037
Multiple Signal Fiber Optic Modems for 4120 Networks	S4100-0049
BACpac Ethernet Module	S4100-0051
4120 Network Products and Specifications	S4100-0056
Physical Bridge Modules for 4120 Networks	S4100-0057
Building Network Interface Card (BNIC)	S4100-0061
SafeLINC Internet Interface	S4100-0062
4100ES Basic Panels with ES-PS Power Supplies	S4100-1031
4100ES Emergency Voice/Alarm Equipment	S4100-1034
InfoAlarm Command Center for Fire Alarm Control Panels with ES-PS Power Supplies	S4100-1045
TrueSite Workstation	S4190-0016
TrueSite Incident Commander	S4190-0020
Network System Integrator (NSI)	S4190-0026

**Expansion Bay Module Loading Reference**

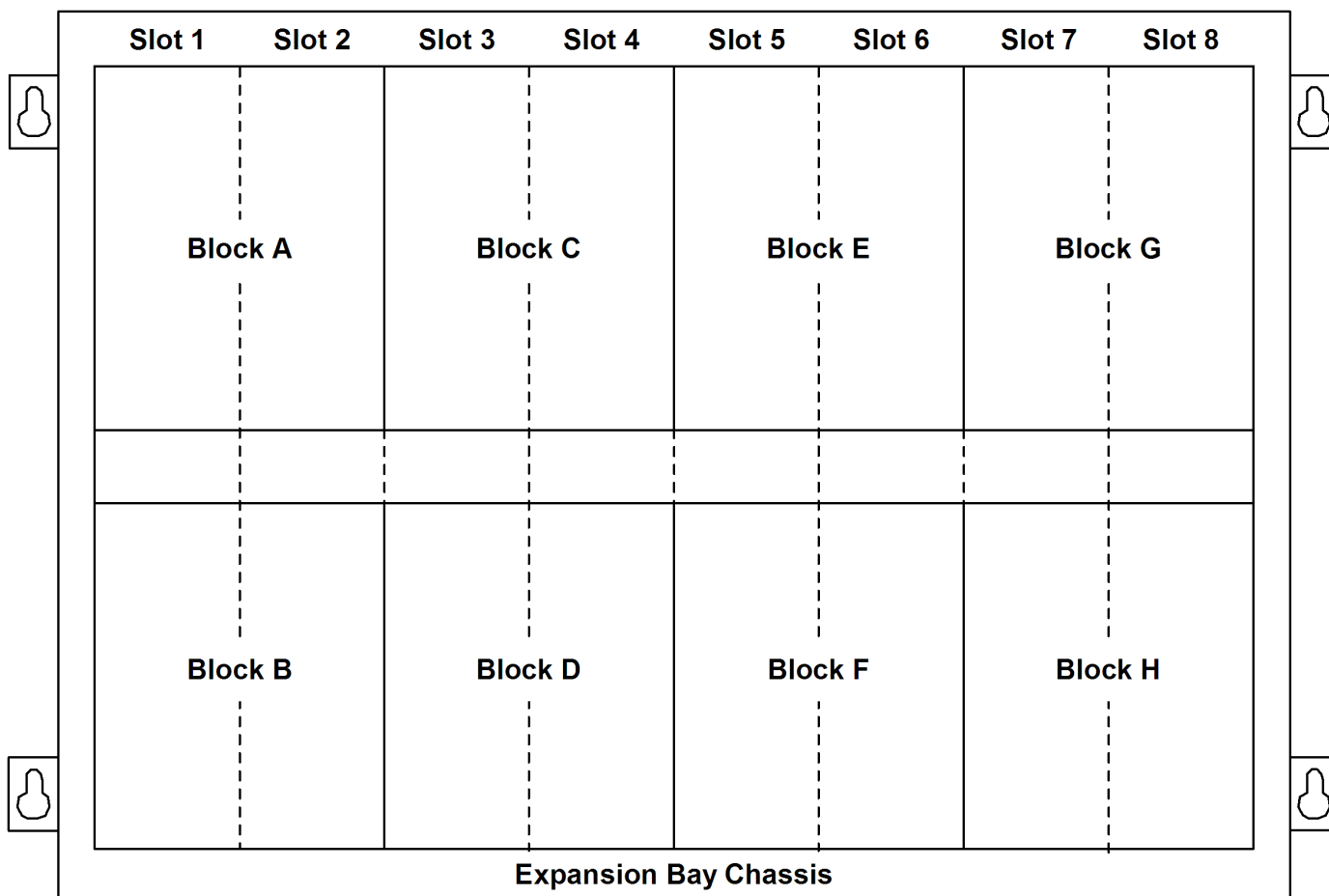

**Size Definitions**

- Block = 4 in. W x 5.65 in. H (102 mm x 144 mm); (often called 4 x 5 modules)
- Slot = 2 in. W x 8 in. H (51 mm x 203 mm) motherboard with daughter card

**Figure 13: Expansion Bay Module Loading Reference**

**Note:** Individual module loading (size) specifications are identified in the NDU Product Selection section and the applicable 4100ES and 4120 Network Product Data Sheets for VCC modules.

### Wall Mounted Enclosure Installation Reference

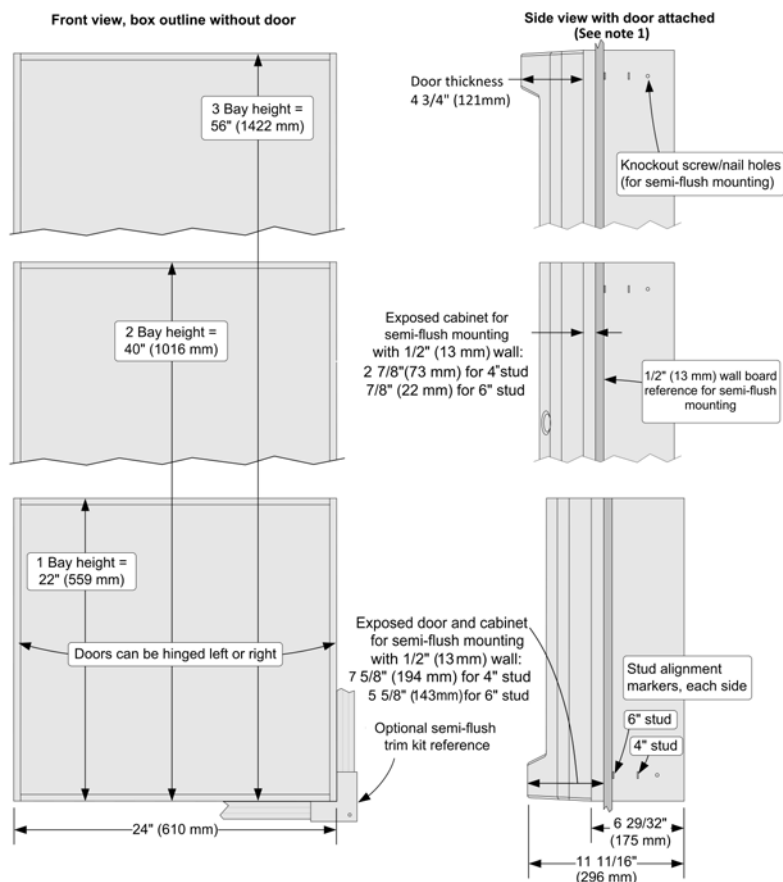

Figure 14: Wall mounted enclosure

**Note:**

1. Side view dimensions are shown with minimal cabinet and door protrusion from the exterior wall. For 6 in. stud construction with minimum protrusion shown, the door will open 90 degrees. To allow the door to open 180 degrees, the exposed cabinet dimension from the exterior wall must be a minimum of 3 in. (76 mm) for both 4 in. and 6 in. stud construction.

2. A system ground must be provided for earth detection and transient protection devices. This connection shall be made to an approved, dedicated earth connection per NFPA 70, article 250, and NFPA 780.

